

BBH35WC080N2U6R1W

BOLT HOLE SWIVEL CASTOR WITH TOTAL BRAKE Ø 80 MM SERIES N2U6 ROLLER BEARING

WHEEL

wheel diameter in mm	80
wheel width in mm	32
hub width in mm	40
screw size	M8
tread	thermopl. polyurethane 95° shore A red
wheel center	polyamide grey
bearing	roller bearing
threadguard	small metal threadguard
temperature range	-40°C to +80°C



HOUSING

material thickness fitting in mm	2.50
material thickness fork in mm	2.50
fitting	bolt hole
mounting dimension in mm	13
offset dimension in mm	40
total height in mm	104
swivel radius in mm	127
dyn. load capacity in kg	130
test norm	DIN EN 12532

**CASCOO Europe GmbH**

Lütke Haar 15 • 59602 Rüthen • Germany
+49 2952 - 970629-0
info@cascoo.eu • www.cascoo.eu

BBH35WC080N2U6R1W

BOLT HOLE SWIVEL CASTOR WITH TOTAL BRAKE Ø 80 MM SERIES N2U6 ROLLER BEARING

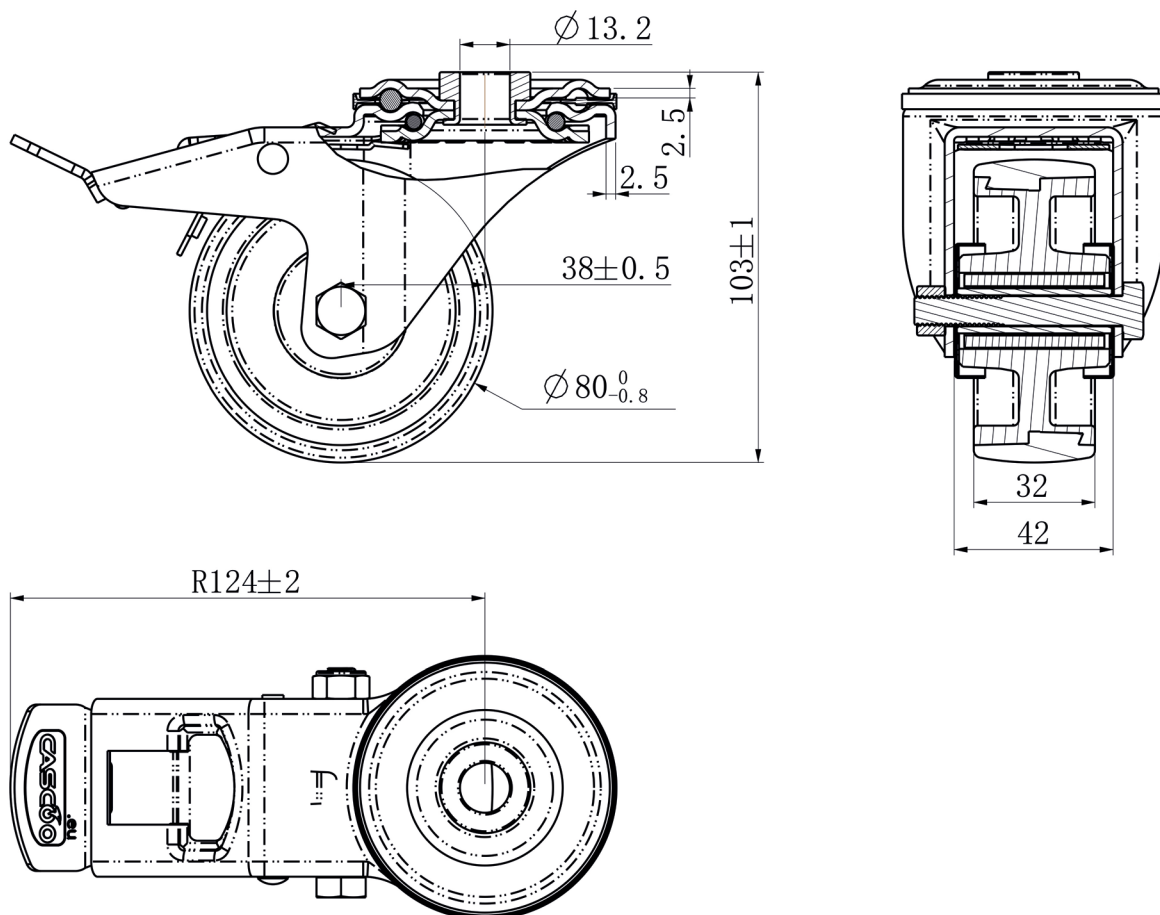

CASCOO Europe GmbH

Lütke Haar 15 • 59602 Rüthen • Germany
+49 2952 - 970629-0
info@cascoo.eu • www.cascoo.eu