

FBP22WC080SWR2R0N

FIXED CASTOR Ø 80 MM SERIES SWR2 ROLLER BEARING

WHEEL

wheel diameter in mm	80
wheel width in mm	27
hub width in mm	40
screw size	M8
tread	solid rubber 85° shore A grey
wheel center	sheet steel blue passivated
bearing	roller bearing
threadguard	without separate threadguard
temperature range	-20°C to +60°C



HOUSING

material thickness fitting in mm	2.00
material thickness fork in mm	2.00
fitting	plate
mounting dimension in mm	80 / 77 x 60
offset dimension in mm	0
total height in mm	105
swivel radius in mm	0
dyn. load capacity in kg	70
test norm	DIN EN 12532

**CASCOO Europe GmbH**

Lütke Haar 15 • 59602 Rüthen • Germany
+49 2952 - 970629-0
info@cascoo.eu • www.cascoo.eu

FBP22WC080SWR2R0N

FIXED CASTOR Ø 80 MM SERIES SWR2 ROLLER BEARING

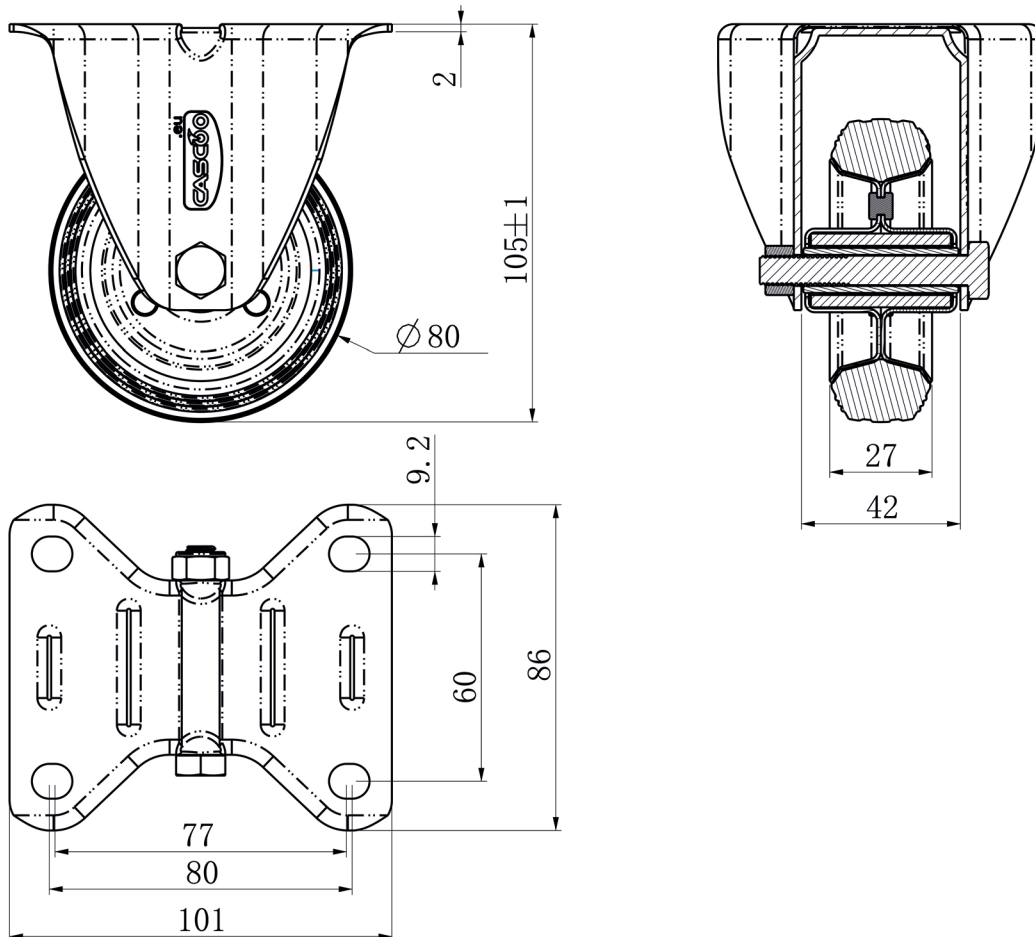

CASCOO Europe GmbH

Lütke Haar 15 • 59602 Rüthen • Germany
+49 2952 - 970629-0
info@cascoo.eu • www.cascoo.eu