

SPP58WC200R4E2D34

## SWIVEL CASTOR Ø 200 MM SERIES R4E2 DOUBLE BALL BEARING

### WHEEL

wheel diameter in mm	200
wheel width in mm	46
hub width in mm	59
screw size	M12
tread	elastic 65° shore A grey
wheel center	polyamide black
bearing	double ball bearing
threadguard	small nylon threadguard
temperature range	-20°C to +80°C



### HOUSING

material thickness fitting in mm	3.50
material thickness fork in mm	3.00
fitting	plate
mounting dimension in mm	105 x 84 / 76
offset dimension in mm	55
total height in mm	235
swivel radius in mm	0
dyn. load capacity in kg	350
test norm	DIN EN 12532



SPP58WC200R4E2D34

# SWIVEL CASTOR Ø 200 MM SERIES R4E2 DOUBLE BALL BEARING

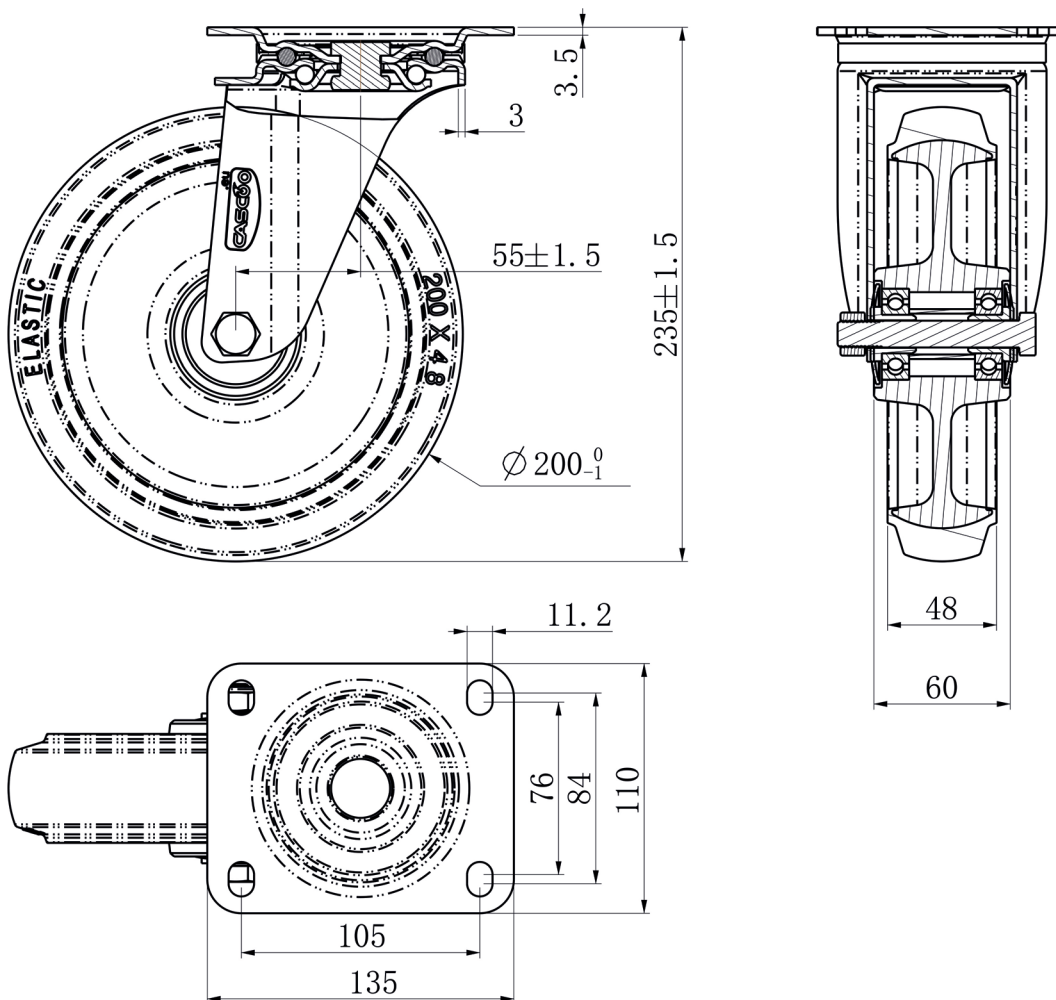

**CASCOO Europe GmbH**

Lütke Haar 15 • 59602 Rüthen • Germany  
+49 2952 - 970629-0  
info@cascoo.eu • www.cascoo.eu