

FIP32SC125N2U6Q0N

FIXED CASTOR Ø 125 MM SERIES N2U6 ROLLER BEARING STAINLESS STEEL

WHEEL

wheel diameter in mm	125
wheel width in mm	32
hub width in mm	50
screw size	M8
tread	thermopl. polyurethane 95° shore A red
wheel center	polyamide grey
bearing	roller bearing stainless steel
threadguard	without separate threadguard
temperature range	-40°C to +80°C



HOUSING

material thickness fitting in mm	2.00
material thickness fork in mm	2.00
fitting	plate
mounting dimension in mm	80 / 77 x 60
offset dimension in mm	0
total height in mm	155
swivel radius in mm	0
dyn. load capacity in kg	200
test norm	DIN EN 12532



CASCOO Europe GmbH

Lütke Haar 15 • 59602 Rüthen • Germany
+49 2952 - 970629-0
info@cascoo.eu • www.cascoo.eu

FIP32SC125N2U6Q0N

FIXED CASTOR Ø 125 MM SERIES N2U6 ROLLER BEARING STAINLESS STEEL

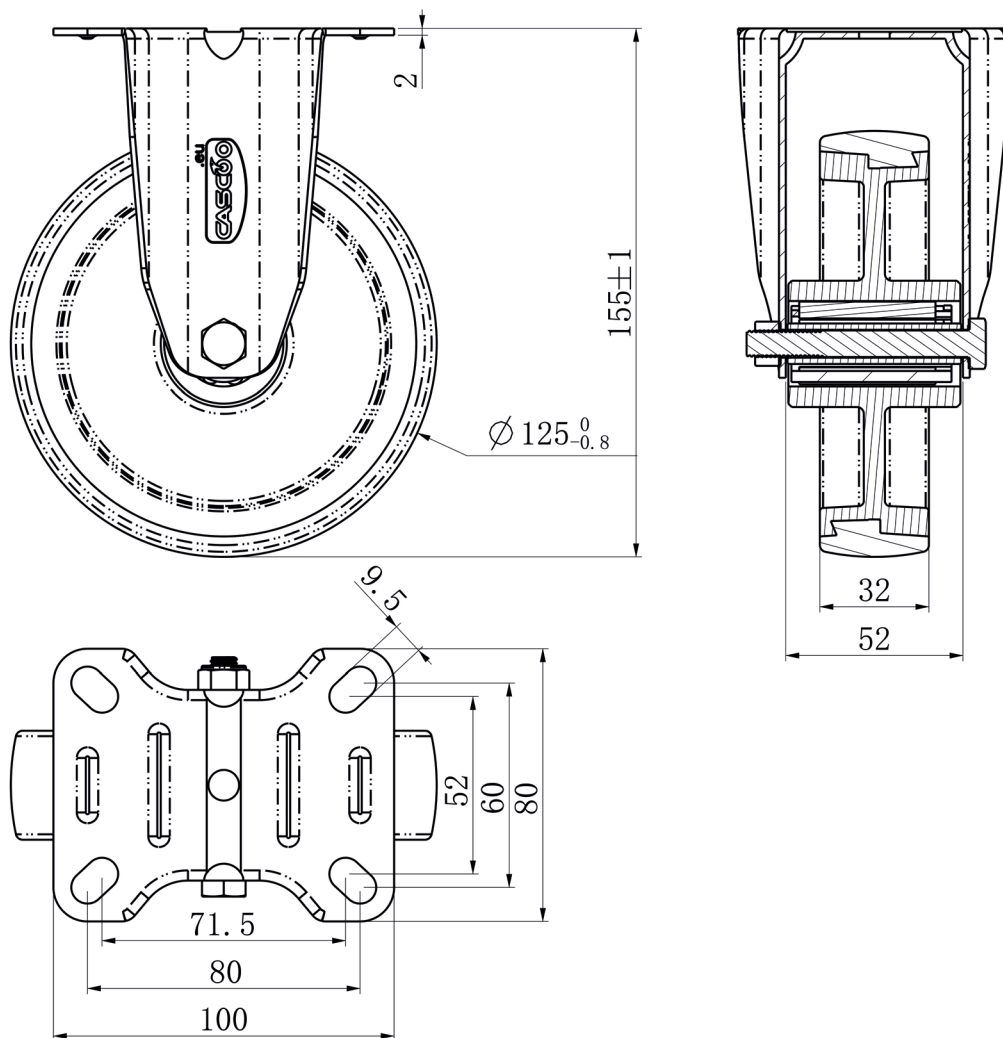

CASCOO Europe GmbH

Lütke Haar 15 • 59602 Rüthen • Germany
+49 2952 - 970629-0
info@cascoo.eu • www.cascoo.eu